















Undertakssystemer



Innehåll

Översikt	3
Modulundertak	4-16
Synlig bärprofil (Ex A)	4-5
Synlig bärprofil med nedhängande plattor (Ex E)	6-7
Profilierad synlig bärprofil med profilerade plattor (Ex Silhouette)	8
Dold bärprofil med symmetriska plattor (Ex Ds)	9
Dold 24 mm bärprofil med asymmetriska plattor (Ex D)	10-11
Dold 35 mm bärprofil med asymmetriska plattor	12
Klämskena 16 mm	13
Klämskena 36 mm	14
Klämskena 45 mm	15
Ej demonterbara	16
Gipstak	17
Linjära paneltak	18
Linjära tak	19

Översikt

		MODULUNDERTAK											Gipstak	
		DEMONTERBARA												Ej demonterbara
		SYNLIG BÄRPROFIL				DOLD BÄRPROFIL								
		15-24 mm	35 mm	15-24 mm	15 mm	24 mm	Asy 24 mm	Asy 35 mm	16 mm	36 mm	45 mm	24 mm		
	A51-R G2	✓	✓	✓	✓	✓ ¹	✓ ¹		✓ ¹	✓ ¹	✓ ¹			
	C77-R	✓	✓	✓	✓	✓ ¹	✓ ¹	✓ ¹	✓ ¹	✓ ¹	✓ ¹		✓ ³	
	C30RIT G2	✓	✓	✓	✓								✓ ³	
	C30RIC G2					✓	✓	✓	✓	✓	✓			
	C25R C35R C95R FLAT2	✓	✓	✓	✓								✓ ³	
	C70R G2 C85R	✓	✓	✓	✓							✓ ²	✓ ²	
	C90R	✓	✓	✓	✓	✓ ¹			✓ ¹	✓ ¹			✓ ³	
	C91-R						✓				✓			
	C91-RE			✓ ⁴	✓ ⁴									
	C92-R						✓							
	C63-R	✓	✓	✓		✓	✓		✓	✓	✓			
	C64-R	✓		✓		✓			✓			✓	✓	
	C80R G2	✓				✓ ¹	✓ ¹	✓ ¹					✓	
	MODERNA2-R	✓	✓	✓	✓								✓ ^{1/3}	

1 - Med monteringsfästen som tillbehör
2 - Med monteringsram som tillbehör

3 - Med ram för gipstak
4 - Endast på förfrå gan

Modulundertak

Taksystem med begränsningar både i bredd och längd, med antingen synlig eller dold bärprofil.

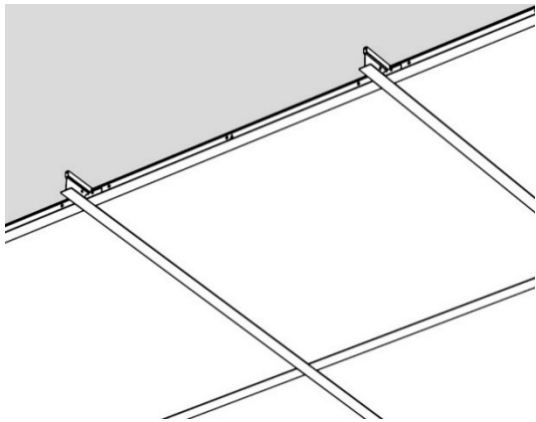

Synlig bärprofil

Synlig bärprofil (Ex A)

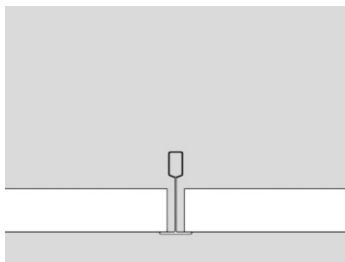

Ecophon A15

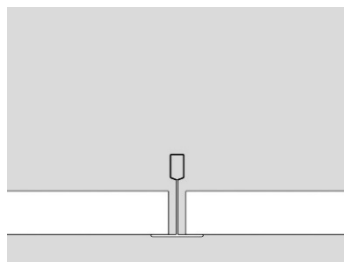

Ecophon A24

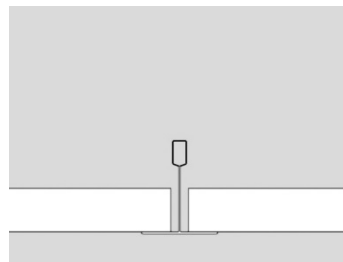

Armstrong Prelude 35

Exempel på leverantörer

AMF SK 15/24, Armstrong Prelude 15/24/35, Burgess Sequence 15/24, Ecophon A15/24, Gyproc Gyptone A15/24, Knauf Danoline A, Lindner LMD-K 403, OWA S 15/3, Paroc A, Rockfon A15/24, Trolldtect K0-S 35

Våra anpassade lösningar

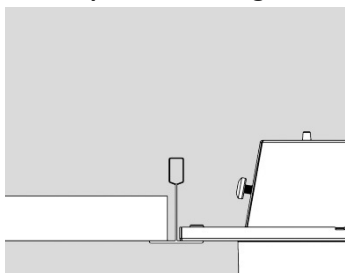

A51-R G2

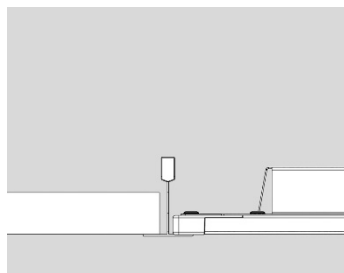

C77-R

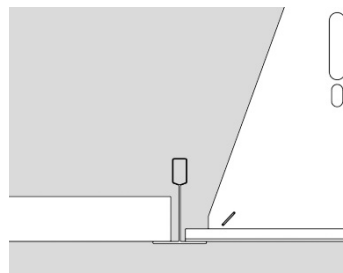

C30-RIT G2

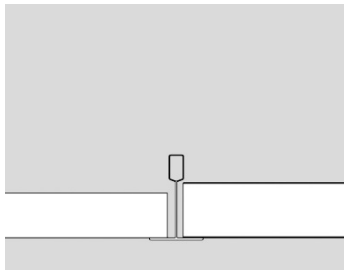

C25-R/C35-R/C95-R
FLAT2/MODERNA2-R

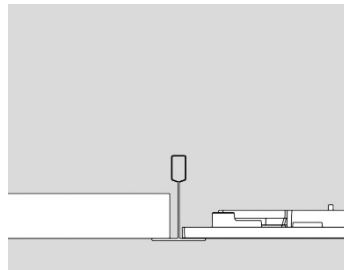

C70-R G2

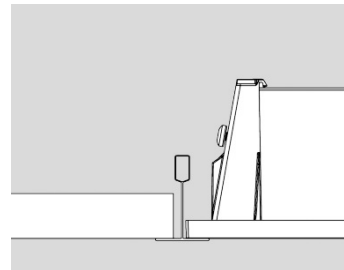

C90-R

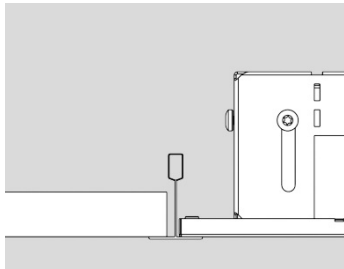

C63-R

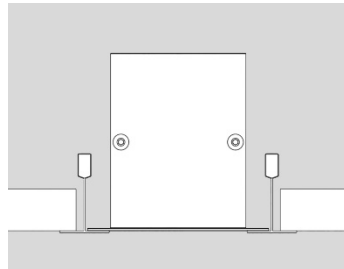

C80-R G2

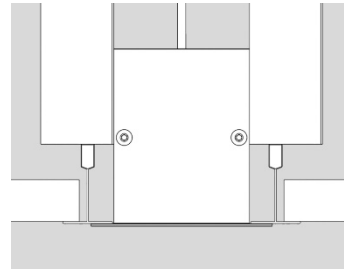

C80-R G2

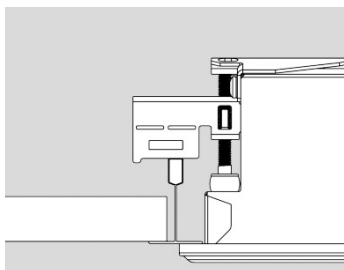

C64-R

Kan endast monteras under bärprofil med hjälp av armaturens inbyggda upphäng.

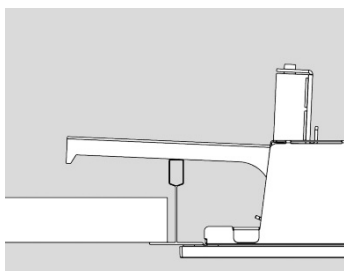

C70-R G2/C85-R
(+ MNT C70-R G2)

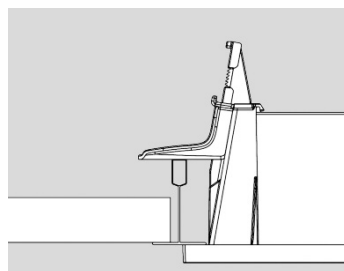

C90-R
(+ MNT C90-R)

Önskas montage under bärprofil rekommenderas C70-R G2 eller C90-R. Detta montage kräver separata monteringskit som levereras som tillbehör.

Synlig bärprofil med nedhängande plattor (Ex E)

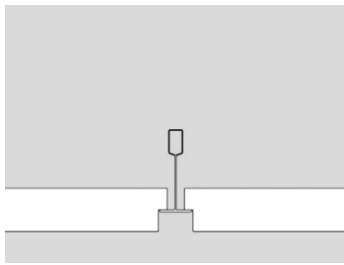

Rockfon E15S

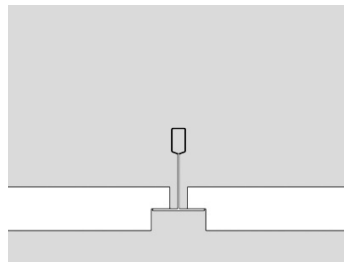

Rockfon E24S

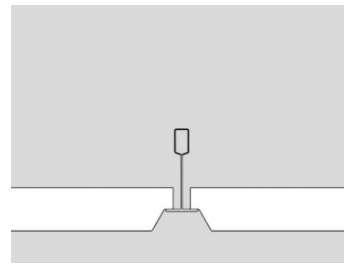

Undertakplattornas profil kan variera i form och djup. Representeras här av Rockfon E15L.

Exempel på leverantörer

AMF VT 15/24, Armstrong Prelude 15/24, Burgess Sequence 15/24, Ecophon E15/24, Gyproc Gyptone E15, Knauf Danoline E/E+, Lindner LMD-K 400, OWA S 15A/3A, Paroc E15/E24, Rockfon E15/24, Trolldtect K0/K3/K5-FS 35

Våra anpassade lösningar

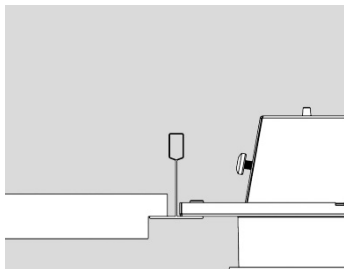

A51-R G2

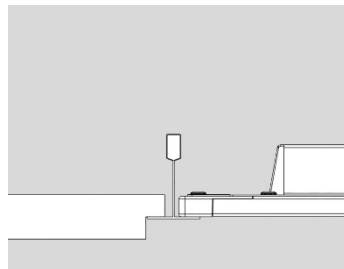

C77-R

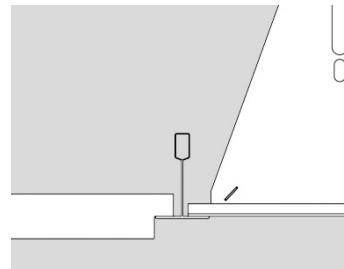

C30-RIT G2

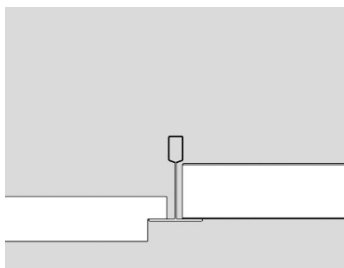

C25-R/C35-R/C95-R
FLAT2/MODERNA2-R

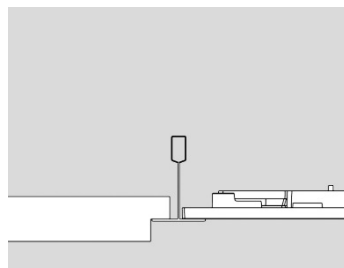

C70-R G2

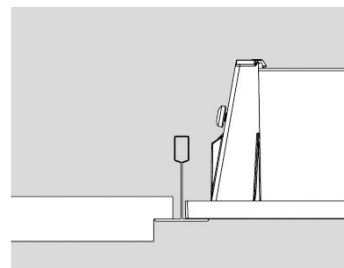

C90-R

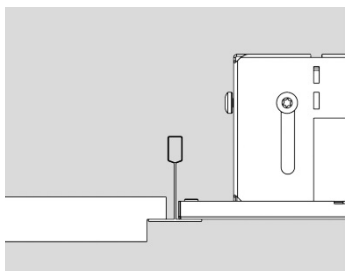

C63-R

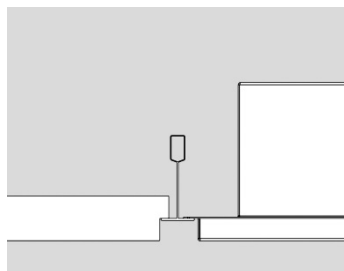

C91-RE (Endast på förfrågan)

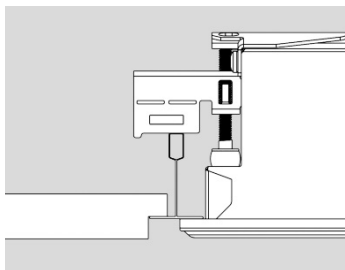

C64-R

Kan endast monteras under bärprofil med hjälp av armaturens inbyggda upphäng.

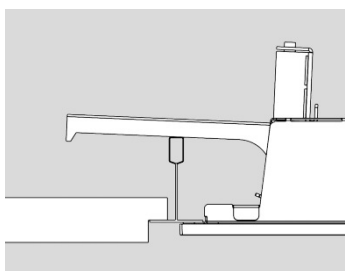

C70-R G2/C85-R
(+ MNT C70-R G2)

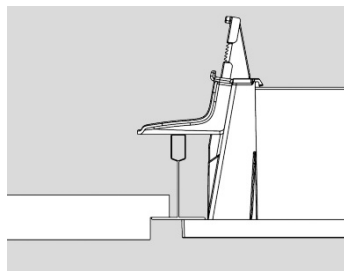

C90-R
(+ MNT C90-R)

Önskas montage under bärprofil rekommenderas C70-R G2 eller C90-R. Detta montage kräver separata monteringskit som levereras som tillbehör.

Profilerad synlig bärprofil med profilerade plattor (Ex Silhouette)

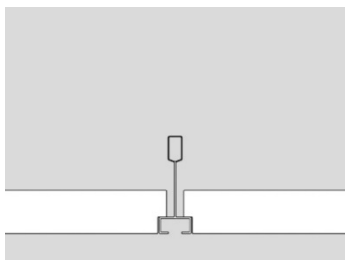

Armstrong Silhouette

Exempel på leverantörer

Armstrong Silhouette, OWA S 15B OWAline, Rockfon E15 Microline, SAS 130

Våra anpassade lösningar

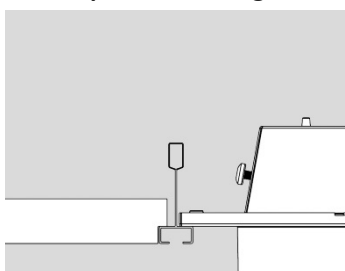

A51-R G2

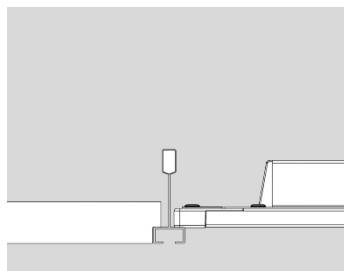

C77-R

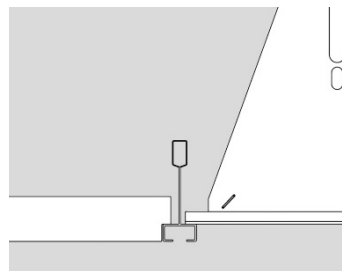

C30-RIT G2

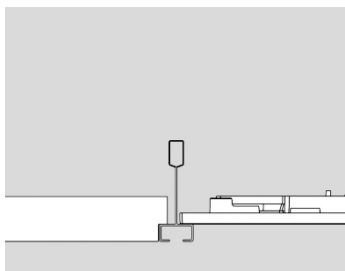

C70-R G2/C85-R

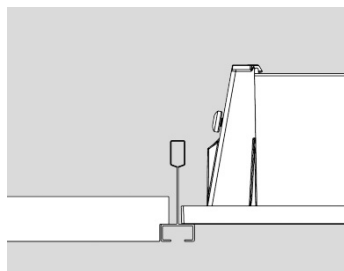

C90-R

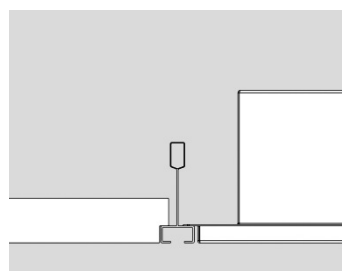

C91-RE (Endast på förfrågan)

Dold bärprofil med symmetriska plattor (Ex Ds)

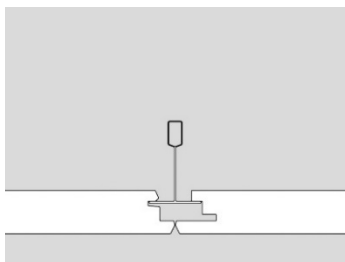

Ecophon Focus Ds

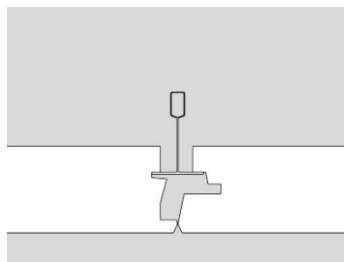

Ecophon Master Ds

Exempel på leverantörer

Burgess Sequence Shiplap T24, Ecophon Focus/Master Ds, Paroc D2, Rockfon T24X

Våra anpassade lösningar

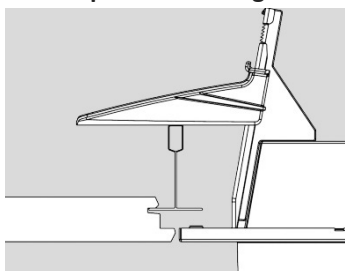

A51-R G2
(+ MNT C20-R G2)

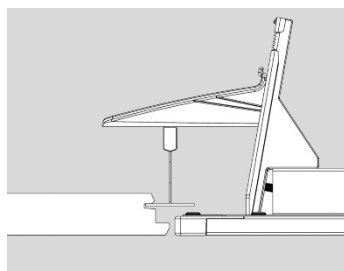

C77-R
(+ MNT C77-R)

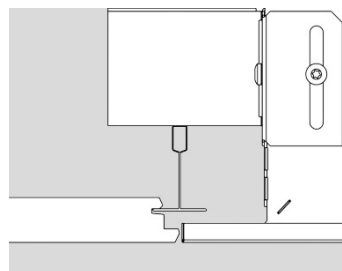

C30-RIC G2

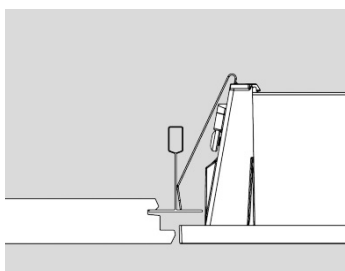

C90-R
(+ MNT CLICK-IN C90-R)

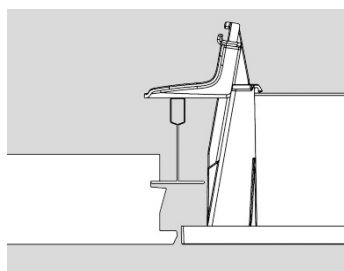

C90-R
(+ MNT C90)

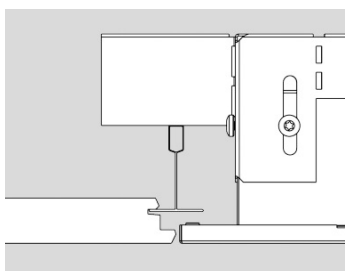

C91-R/C63-R

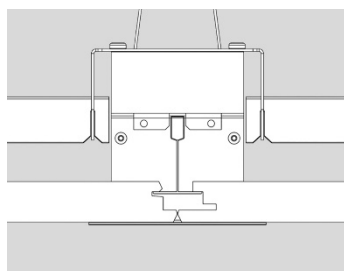

C80-R G2
(+MNT DS/T24X)

Dold 24 mm bärprofil med asymmetriska plattor

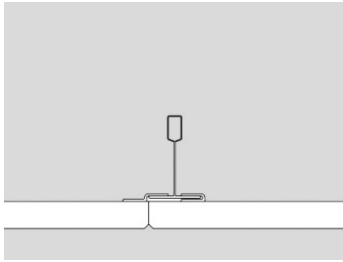

Gyproc Gyptone D1

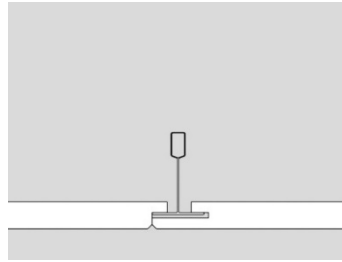

Gyproc Gyptone D2

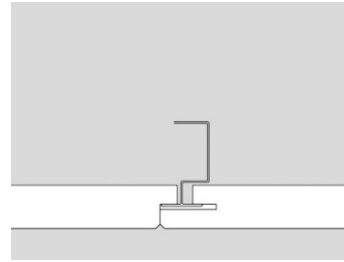

Rockfon D-XL

Exempel på leverantörer

AMF AW, Gyproc Gyptone D1/D2, Knauf Danoline D/D+, OWA S 9b, Paroc D, Rockfon D-XL/H

Våra anpassade lösningar

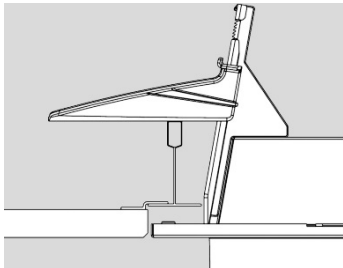

A51-R G2
(+ MNT C20-R G2)

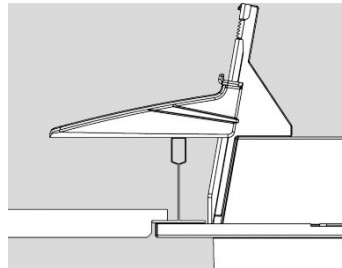

A51-R G2
(+ MNT C20-R G2)

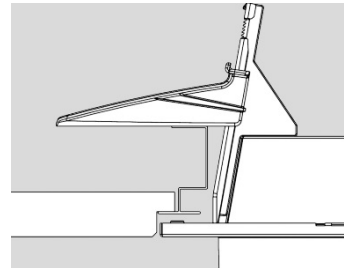

A51-R G2
(+ MNT C20-R G2)

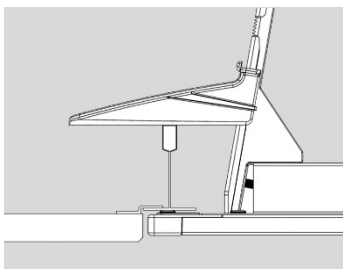

C77-R
(+ MNT C77-R)

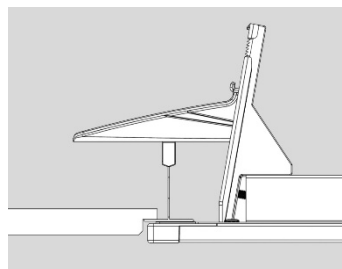

C77-R
(+ MNT C77-R)

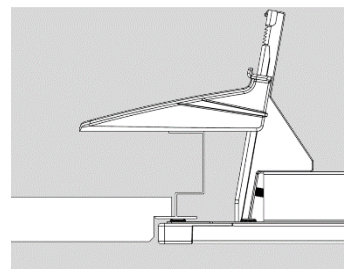

C77-R
(+ MNT C77-R)

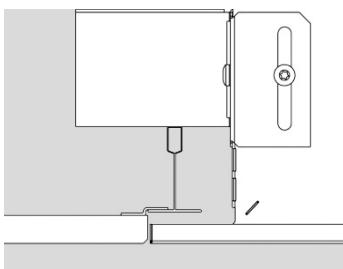

C30-RIC G2

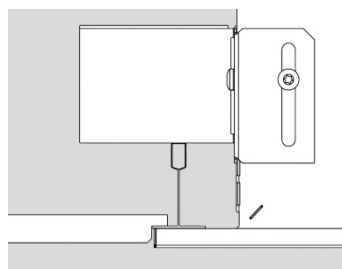

C30-RIC G2

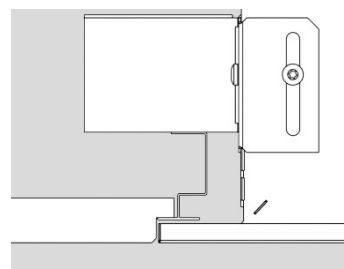

C30-RIC G2

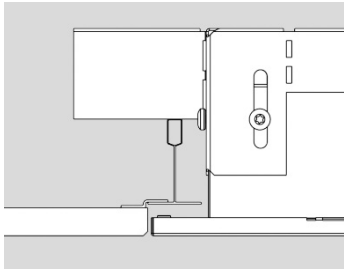

C91-R/C63-R

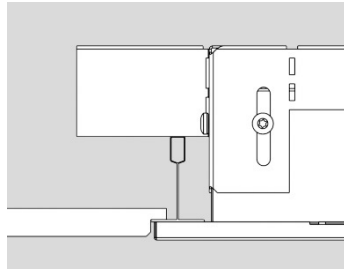

C91-R/C63-R

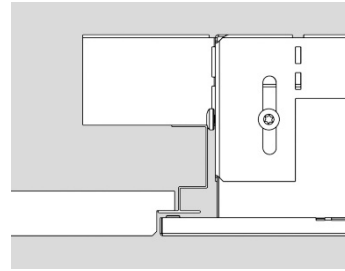

C91-R/C63-R

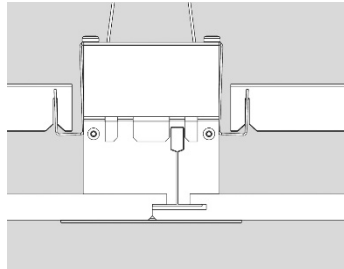

C80-R G2
(+MNT GYPTONE D2)

Dold 35 mm bärprofil med asymmetriska plattor

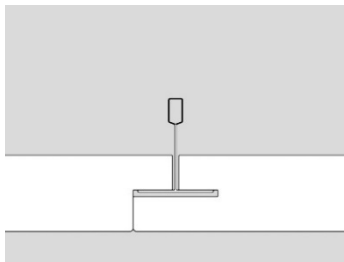

Troldekt T35

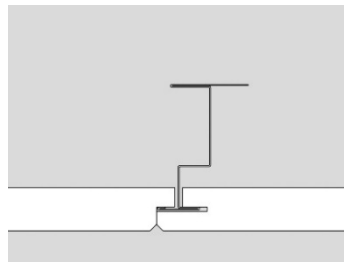

OWA S 9a

Exempel på leverantörer

INLOOK VK-10, Troldekt K5-FN 35, OWA S 9a

Våra anpassade lösningar

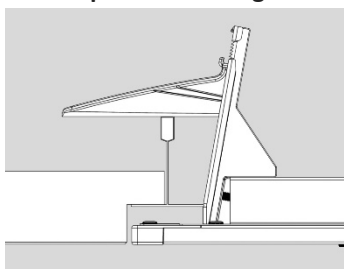

C77-R
(+ MNT C77-R)

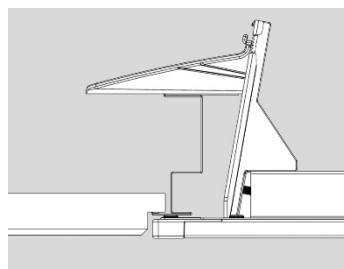

C77-R
(+ MNT C77-R)

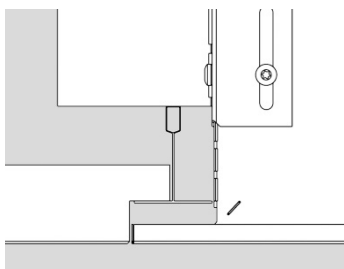

C30-RIC G2

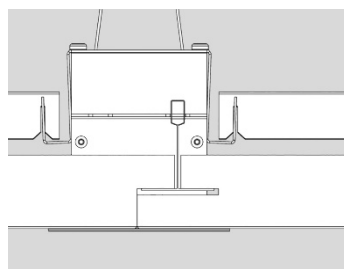

C80-R G2
(+MNT TROLDEKT T35)

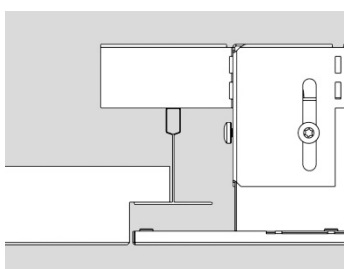

C92-R

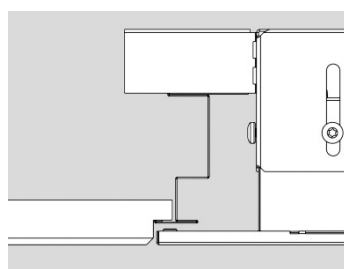

C92-R

Klämskena 16 mm

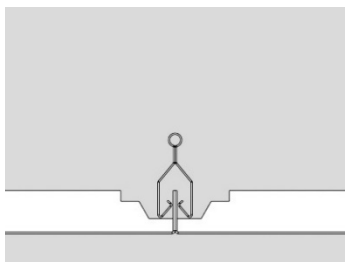

OWA S 22

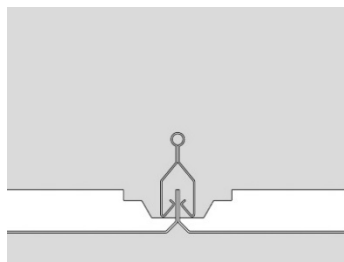

Undertaket kan levereras i 47, 52, 59 eller 67 mm höjd med antingen rak kant eller fasat hörn.

Exempel på leverantörer

Armstrong Q-Clip/R-Clip/S-Clip F, Burgess Clip In A-Bar, Fural K, Lindner LMD-K 420, OWA S 22/31/32, SAS 150

Våra anpassade lösningar

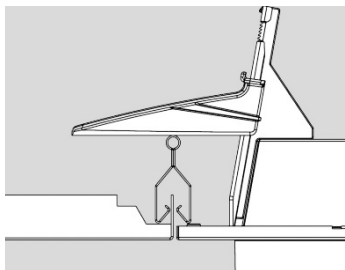

A51-R G2
(+ MNT C20-R G2)

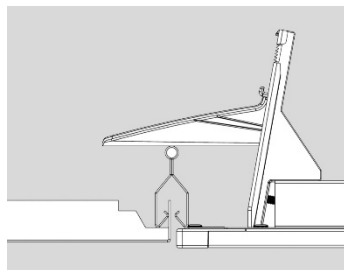

C77-R
(+ MNT C77-R)

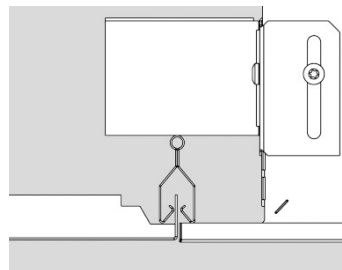

C30-RIC G2

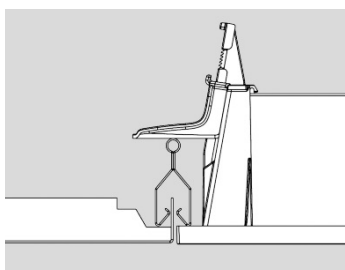

C90-R
(+ MNT C90)

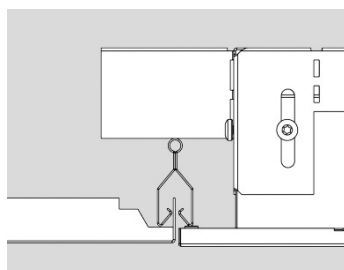

C91-R/C63-R

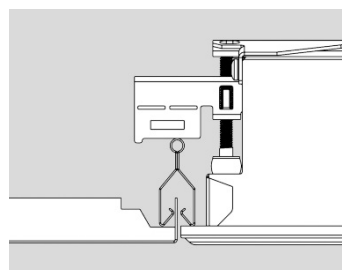

C64-R

Klämskena 36 mm

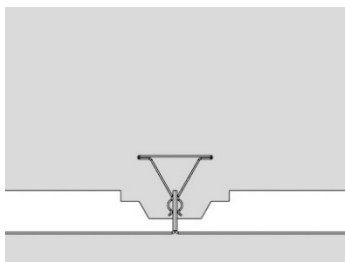

Dampa Clip-In

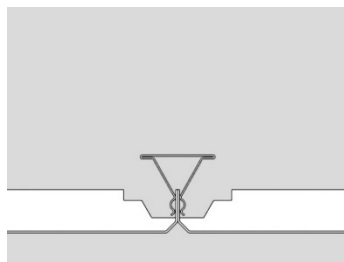

Undertaket kan levereras i 36 (Dampa Clip-In / Meta Klemkassett) eller 45 mm höjd (Armstrong T-Clip F / SAS 120) med antingen rak kant eller fasat hörn.

Exempel på leverantörer

Armstrong T-Clip F, Dampa Clip-In, Meta Klemkassett, SAS 120

Våra anpassade lösningar

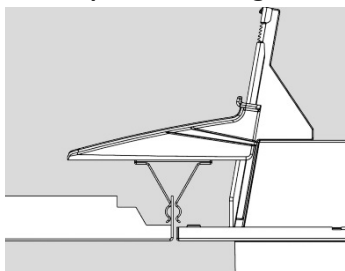

A51-R G2
(+ MNT C20-R G2)

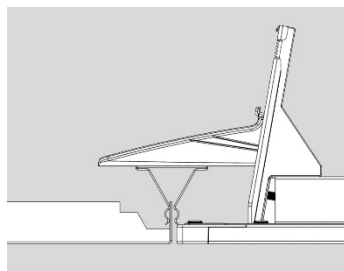

C77-R
(+ MNT C77-R)

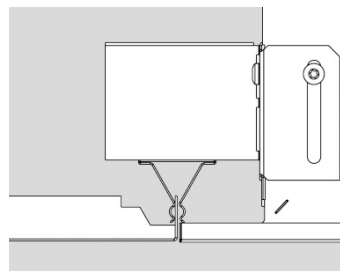

C30-RIC G2

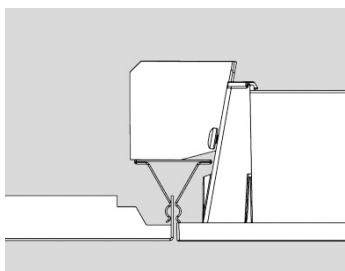

C90-R
(+ MNT SPRING-T36 C90-R)

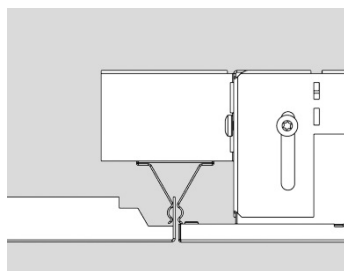

C91-R/C63-R

Klämskena 45 mm

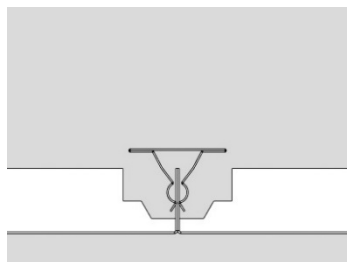

Burgess Clip-In

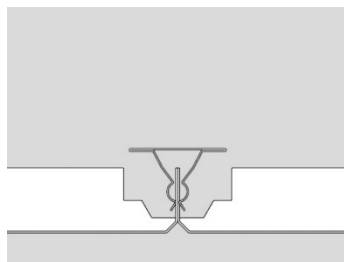

Undertaket kan levereras i 39 (Burgess Clip-In) eller 45 mm höjd (Armstrong Orcal 1800/Burgess Clip-In) med antingen rak kant eller fasat hörn.

Exempel på leverantörer

Armstrong Orcal 1800, Burgess Clip-In

Våra anpassade lösningar

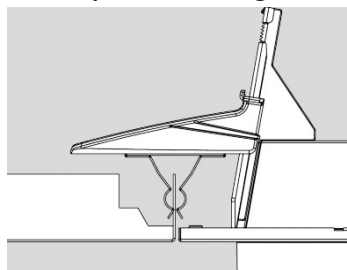

A51-R G2
(+ MNT C20-R G2)

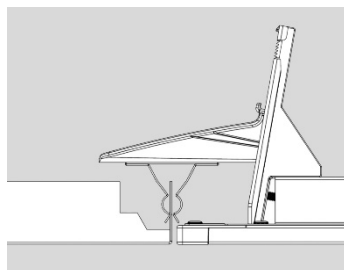

C77-R
(+ MNT C77-R)

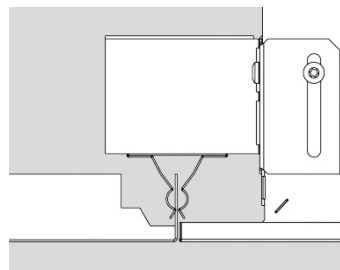

C30-RIC G2

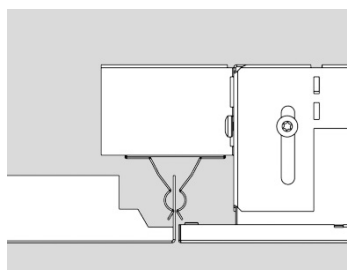

C91-R/C63-R

Ej demonterbara

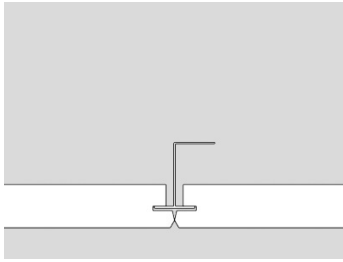

Rockfon C

Exempel på leverantörer

AMF GN, Rockfon C

Våra anpassade lösningar

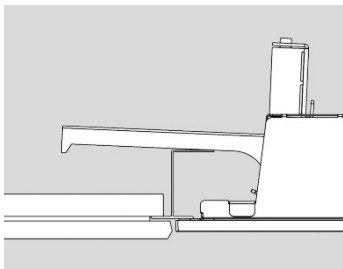

C70-R G2/C85-R
(+ MNT C70-R G2)

Gipstak

Tak som inte är modulära där hål i tak måste anpassas till armaturdesignen.

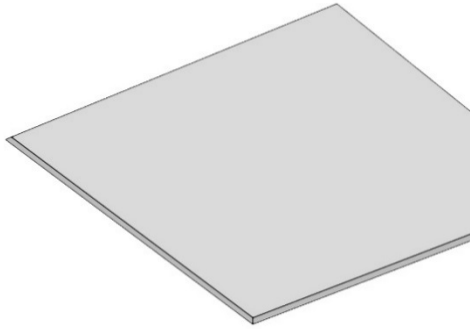

Anpassat hål i tak

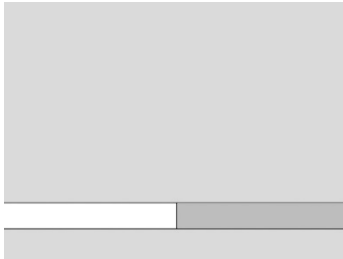

Gipstak

Våra anpassade lösningar

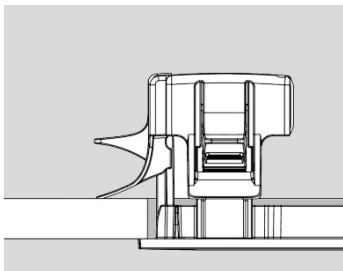

MNT FRAME PLASTERBOARD

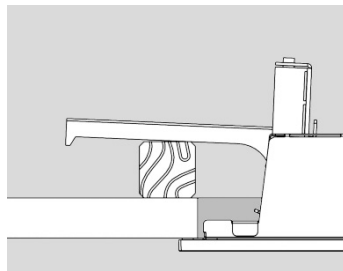

C70-R G2/C85-R
(+ MNT C70-R G2)

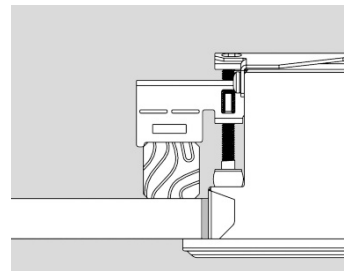

C64-R

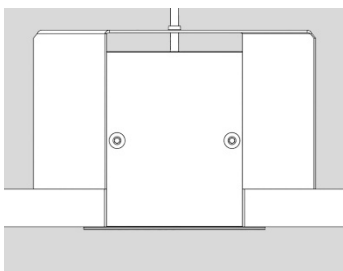

C80-R G2

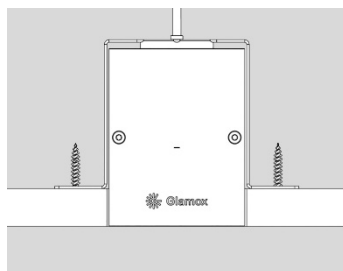

C80-S G2
(+MNT TRIMLESS)

Linjära paneltak

Tak med stora bärprofiler där kortändarna av takpanelerna vilar. Bärprofilerna har olika bredder och design, samt längder mellan dessa varierar.

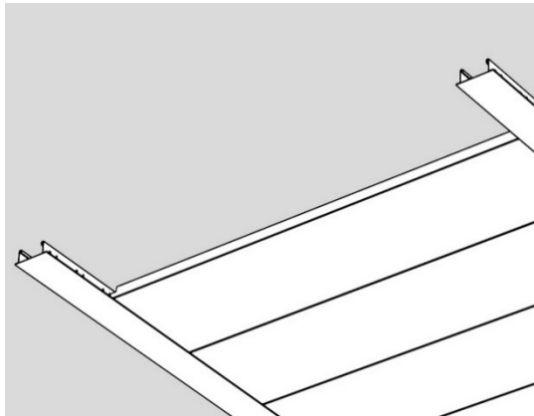

Liggande

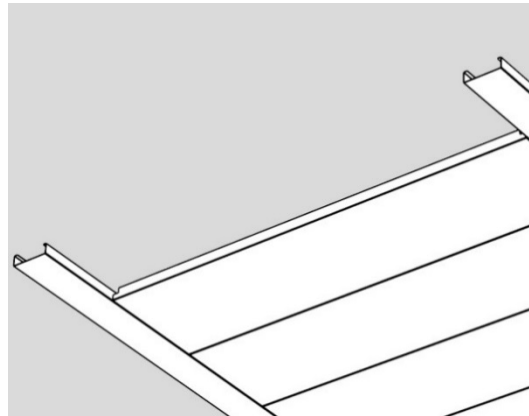

Hängande

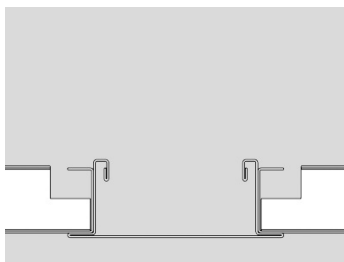

Armstrong liggande

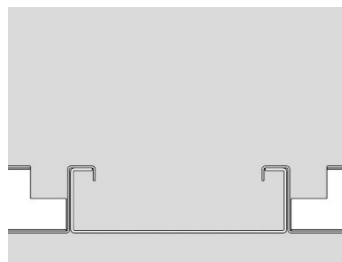

Armstrong hängande

Exempel på leverantörer

Armstrong linear grid, SAS 330

Våra anpassade lösningar

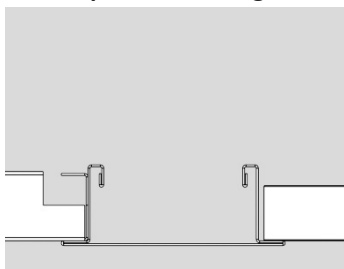

C95-R

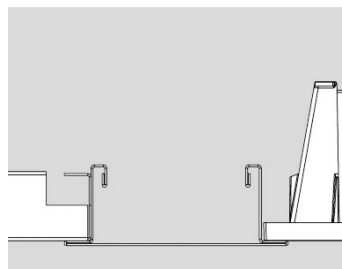

C90-R

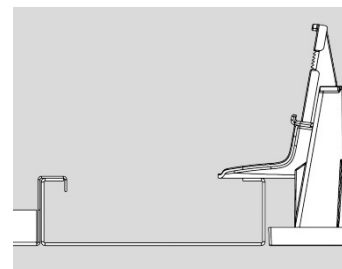

C90-R
(+ MNT C90-R)

För liggande version med takplattor 300 x 1200 eller 312 x 1250 mm, rekommenderar vi att C20-R G2, C95-R, C90-R eller C63-R användas. För hängande version passar C90-R eller C63-R bäst.

Linjära tak

Linjära tak finns i många modulbredder (vanligen 100, 150, 200 och 300 mm) med begränsning i endast en riktning (tvärs). Panelerna är profilerade på varje sida, antingen i en öppen eller fast konstruktion. Panelerna varierar mycket i både höjd och utformning.

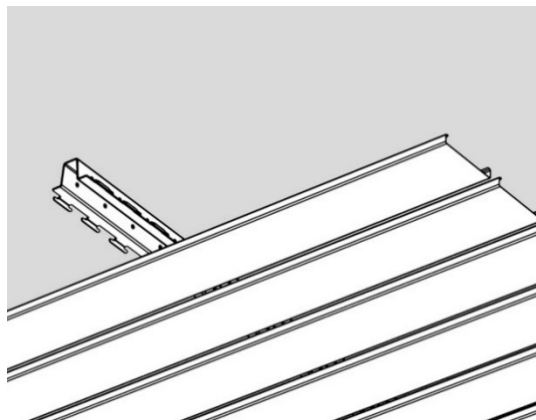

Öppet linjärt tak

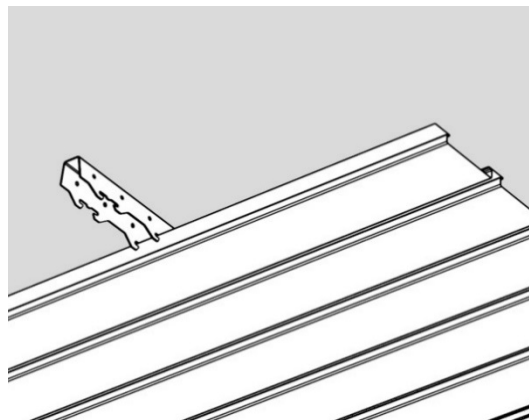

Fast linjärt tak

Exempel på leverantörer

Dampa, Hunter Douglas

Möjliga lösningar

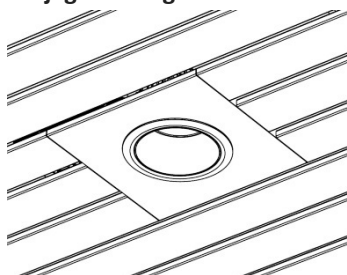

D70-R

Eftersom linjära tak har så många olika utföranden, rekommenderar vi att använda infällda downlights eller andra lösningar, till exempel pendlade armaturer.



Glamox Gruppen

Glamox är en norsk industrikoncern som utvecklar, tillverkar och distribuerar professionella belysningslösningar för den globala marknaden. Vår mission är att tillhandahålla hållbara belysningslösningar som förbättrar människors prestanda och välbefinnande.

Hög prestanda och användarvänlighet
Våra lösningar är designade för att kombinera hög prestanda och hållbarhet med enkelhet och användarvänlighet, vilket ger en överlägsen kundupplevelse. Vi använder den senaste teknologin på ett smart sätt och förser den med generationer av erfarenhet och genuin omsorg för våra kunder.

Kvalitetsmärken och hängiven support
Vi erbjuder en rad olika högkvalitativa varumärken av belysningsprodukter. Oavsett varumärke, är den nära uppföljningen av varje kund, kärnan i vår verksamhet. Oavsett om det är i en produktionsanläggning, ett fiskefartyg eller en kontorsbyggnad är vår ambition att tillhandahålla belysning som bidrar till ett bättre liv för de företag vi betjänar och för de människor som arbetar där.

För mer info, gå in på www.glamox.com

