



Alakattojärjestelmä



Sisällysluettelo

| | |
|---|-------------|
| Yleiskatsaus | 3 |
| Modulikatot | 4-16 |
| Näkyvä T-listajärjestelmä | 4-5 |
| Osittain piiloon jäävä T-listajärjestelmä | 6-7 |
| Osittain piiloon jäävä profiililistajärjestelmä | 8 |
| Avattava piilolistajärjestelmä | 9 |
| Epäsymmetrinen avattava 24mm piilolistajärjestelmä | 10-11 |
| Epäsymmetrinen avattava 35mm piilolistajärjestelmä | 12 |
| Metallikasettikatto 16mm piilotetulla A-listajärjestelmällä | 13 |
| Metallikasettikatto 36mm piilotetulla T-listajärjestelmällä | 14 |
| Metallikasettikatto 45mm piilotetulla T-listajärjestelmällä | 15 |
| Suljettu modulikatto | 16 |
| Kipsilevykatot | 17 |
| Paneelikatot | 18 |
| Sälekatot | 19 |

Yleiskatsaus

| | | MODULIKATOT | | | | | | | | | | Suljettu modulikatot | Kipsilevykatot |
|---|----------------------------------|-----------------|-------|----------------|----------------|-----------------------|----------------|----------------|----------------|----------------|----------------|-------------------------|------------------|
| | | AVATTAVAT KATOT | | | | | | | | | | | |
| | | NÄKYVÄ PROFILI | | | | PIILOLISTAJÄRJESTELMÄ | | | | | | | |
| | | 15-24 mm | 35 mm | 15-24 mm | 15 mm | 24 mm | Asy 24 mm | Asy 35 mm | 16 mm | 36 mm | 45 mm | | |
|  | A51-R G2 | ✓ | ✓ | ✓ | ✓ | ✓ ¹ | ✓ ¹ | | ✓ ¹ | ✓ ¹ | ✓ ¹ | | |
|  | C77-R | ✓ | ✓ | ✓ | ✓ | ✓ ¹ | ✓ ¹ | ✓ ¹ | ✓ ¹ | ✓ ¹ | ✓ ¹ | | ✓ ³ |
|  | C30RIT G2 | ✓ | ✓ | ✓ | ✓ | | | | | | | | ✓ ³ |
|  | C30RIC G2 | | | | | ✓ | ✓ | ✓ | ✓ | ✓ | | | |
|  | C25-R C35-R C95-R FLAT2 | ✓ | ✓ | ✓ | ✓ | | | | | | | | ✓ ³ |
|  | C70R G2 C85-R | ✓ | ✓ | ✓ | ✓ | | | | | | ✓ ² | | ✓ ² |
|  | C90R | ✓ | ✓ | ✓ | ✓ | ✓ ¹ | | | ✓ ¹ | ✓ ¹ | | | ✓ ³ |
|  | C91-R | | | | | | ✓ | | | ✓ | | | |
|  | C91-RE | | | ✓ ⁴ | ✓ ⁴ | | | | | | | | |
|  | C92-R | | | | | | ✓ | | | | | | |
|  | C63-R | ✓ | ✓ | ✓ | | ✓ | ✓ | | ✓ | ✓ | ✓ | | |
|  | C64-R | ✓ | | ✓ | | ✓ | | | ✓ | | | ✓ | ✓ |
|  | C80R G2 | ✓ | | | | ✓ ¹ | ✓ ¹ | ✓ ¹ | | | | | ✓ |
|  | MODERNA2-R | ✓ | ✓ | ✓ | ✓ | | | | | | | | ✓ ^{1/3} |

1 - Lisävarusteena saatavalla asennussarjalla
2 - Lisävarusteena saatavalla
asennuskehyksellä

3 - Lisävarusteena saatavalla asennuskehyksellä kipsilevykattoon
4 - Vain erikoistilauksesta

Modulikatot

Alakattojärjestelmä, jossa käytetään standardoitua moduli-mittaa. T-listat voivat olla näkyviä tai piilotettuja.

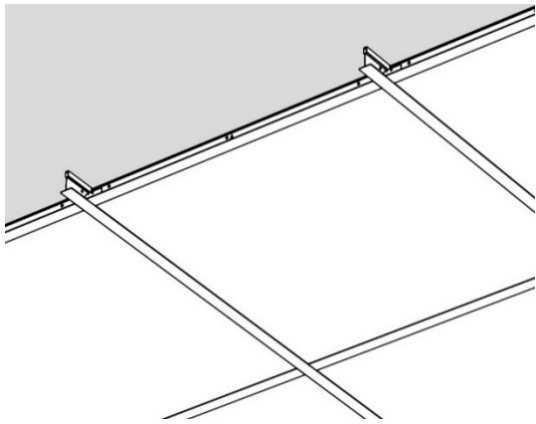

Näkyvä T-listajärjestelmä

Näkyvä T-listajärjestelmä

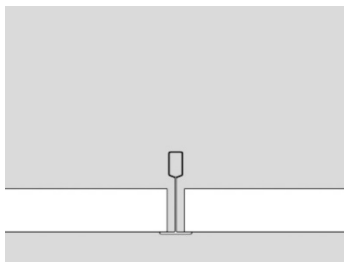

Ecophon A15

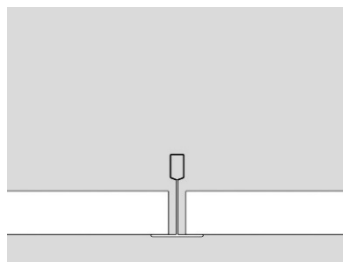

Ecophon A24

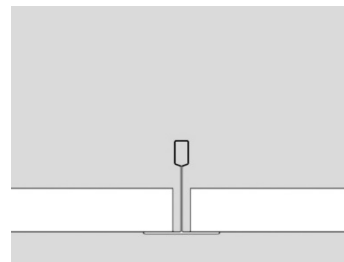

Armstrong Prelude 35

Esimerkkejä

AMF SK 15/24, Armstrong Prelude 15/24/35, Burgess Sequence 15/24, Ecophon A15/24, Gyproc Gyptone A15/24, Knauf Danoline A, Lindner LMD-K 403, OWA S 15/3, Paroc A, Rockfon A15/24, Trolldtekt K0-S 35

Ratkaisumme

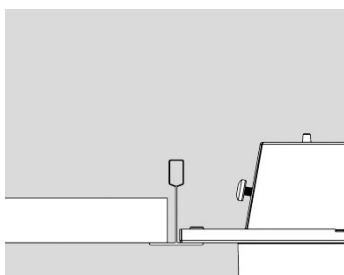

A51-R G2

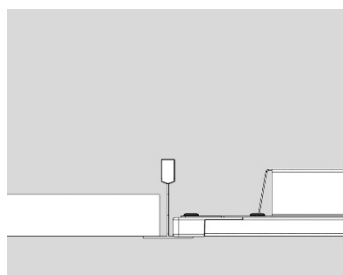

C77-R

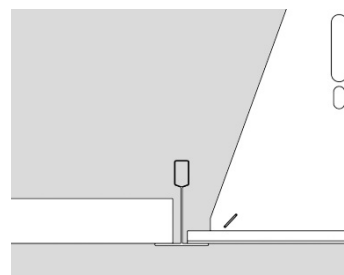

C30-RIT G2

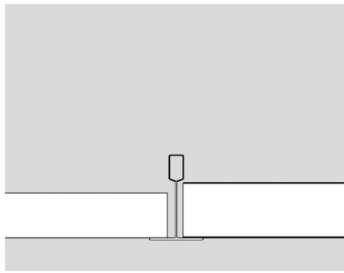

C25-R/C35-R/C95-R
FLAT2/MODERNA2-R

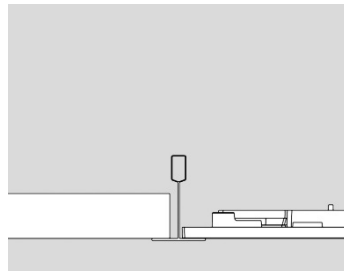

C70-R G2

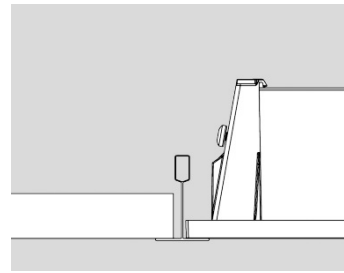

C90-R

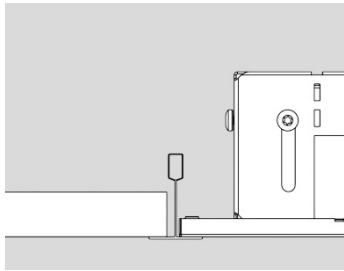

C63-R

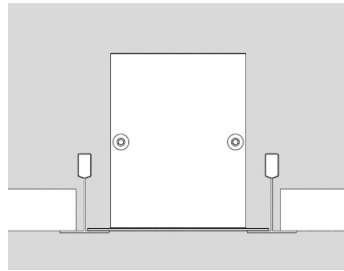

C80-R G2

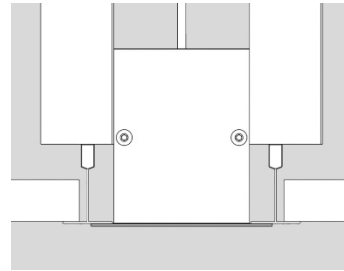

C80-R G2

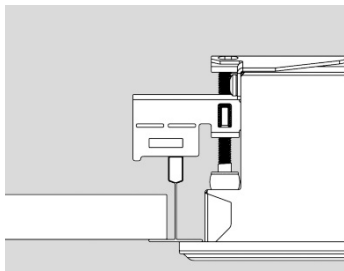

C64-R
Vain alapuoliseen asennukseen.

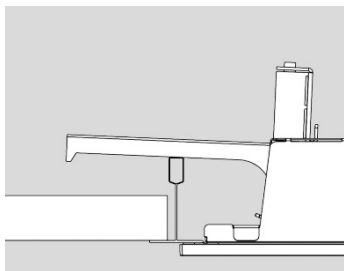

C70-R G2/C85-R
(+ MNT C70-R G2)

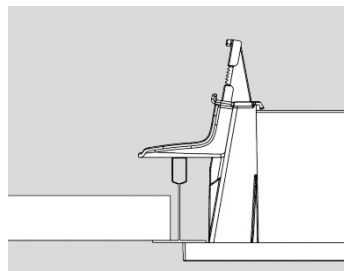

C90-R
(+ MNT C90-R)

Alaspuoliseen asennukseen suosittelemme C70-R G2 or C90-R. Alapuolinen asennus vaatii asennussarjan, joka on saatavana lisävarusteena.

Osittain piiloon jäävä T-listajärjestelmä

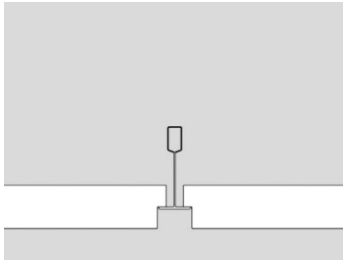

Rockfon E15S

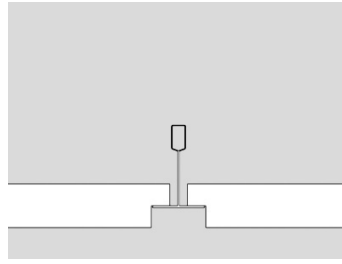

Rockfon E24S

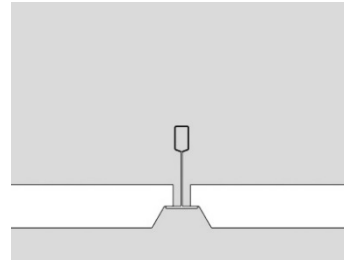

Osittain piiloon jäävän listajärjestelmän kattolevyjen reunamuoto ja kattolevyn paksuus voivat vaihdella. Tässä esitelty Rockfon E15L.

Esimerkkejä

AMF VT 15/24, Armstrong Prelude 15/24, Burgess Sequence 15/24, Ecophon E15/24, Gyproc Gyptone E15, Knauf Danoline E/E+, Lindner LMD-K 400, OWA S 15A/3A, Paroc E15/E24, Rockfon E15/24, Troldekt K0/K3/K5-FS 35

Ratkaisumme

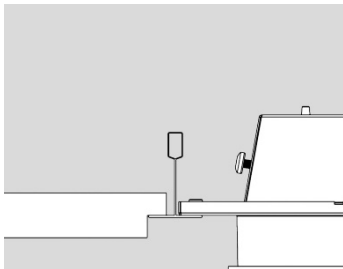

A51-R G2

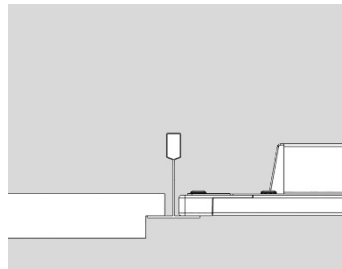

C77-R

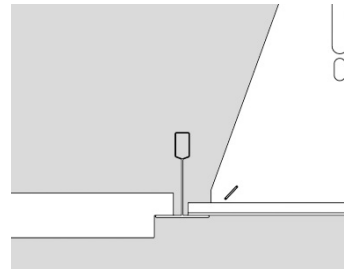

C30-RIT G2

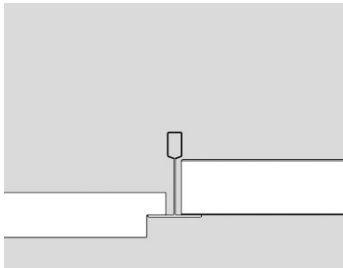

C25-R/C35-R/C95-R
FLAT2/MODERNA2-R

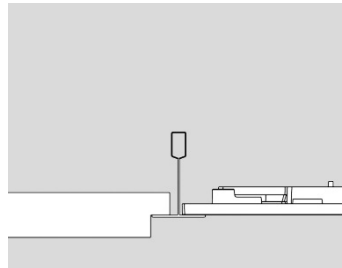

C70-R G2

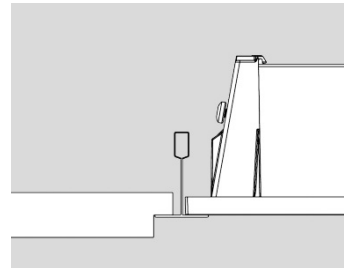

C90-R

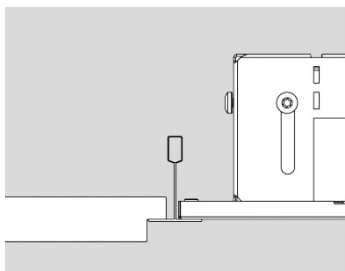

C63-R

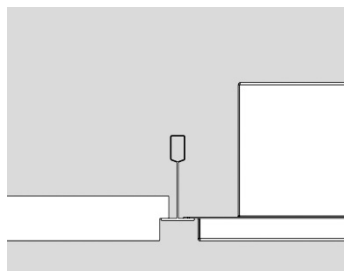

C91-RE (vain erikoistilauksesta)

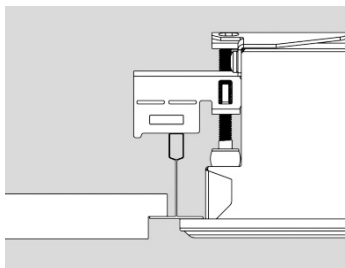

C64-R

Vain alapuoliseen asentukseen.

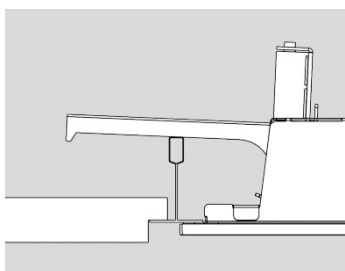

C70-R G2/C85-R
(+ MNT C70-R G2)

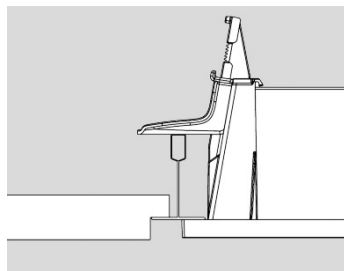

C90-R
(+ MNT C90-R)

Alaspuoliseen asentukseen suosittelemme C70-R G2 or C90-R. Alapuolinen asennus vaatii asennussarjan, joka on saatavana lisävarusteena.

Osittain piiloon jäävä profiilijärjestelmä

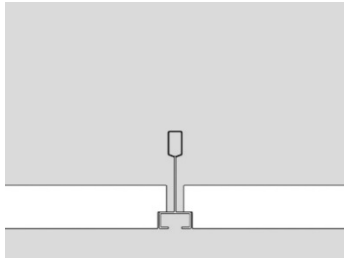

Armstrong Silhouette

Esimerkkejä

Armstrong Silhouette, OWA S 15B OWAline, Rockfon E15 Microline, SAS 130

Ratkaisumme

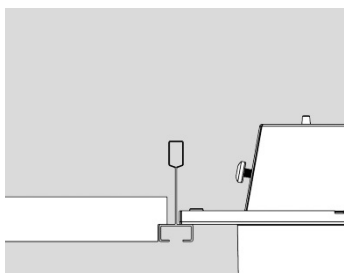

A51-R G2

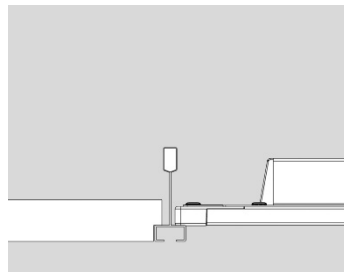

C77-R

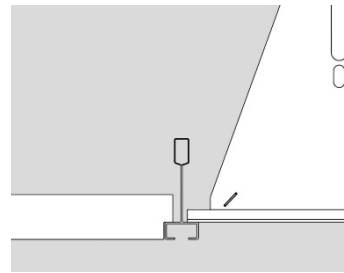

C30-RIT G2

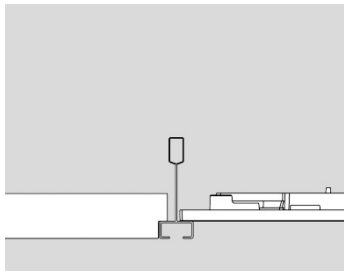

C70-R G2/C85-R

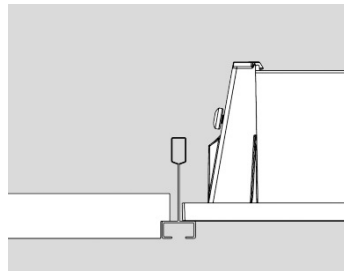

C90-R

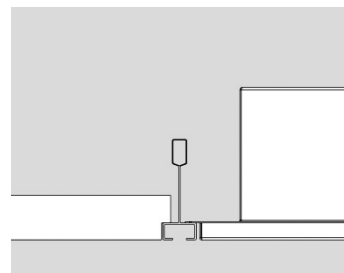

C91-RE (Vain erikoistilauksesta)

Avattava piilolistajärjestelmä

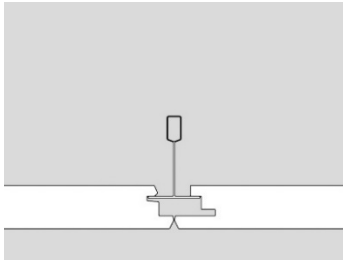

Ecophon Focus Ds

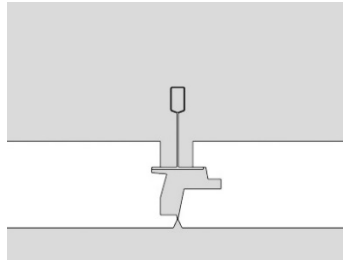

Ecophon Master Ds

Esimerkkejä

Burgess Sequence Shiplap T24, Ecophon Focus/Master Ds, Paroc D2, Rockfon T24X

Ratkaisumme

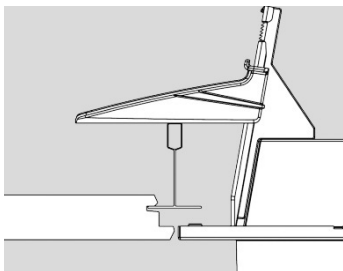

A51-R G2
(+ MNT C20-R G2)

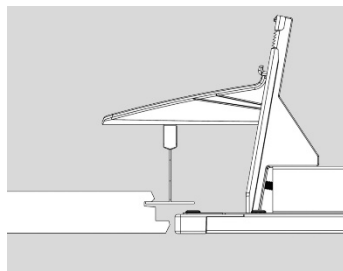

C77-R
(+ MNT C20-R G2)

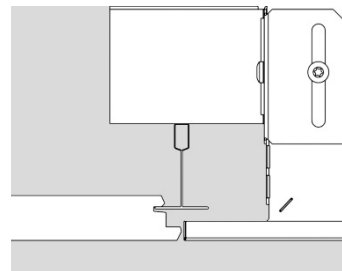

C30-RIC G2

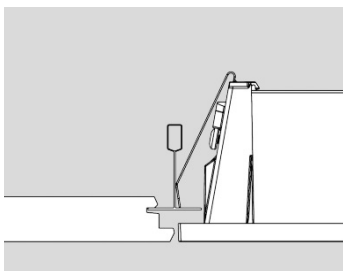

C90-R
(+ MNT CLICK-IN C90-R)

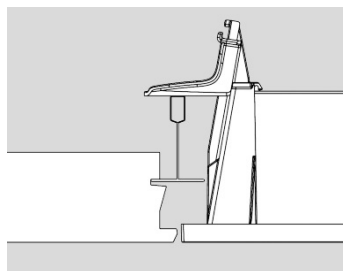

C90-R
(+ MNT C90)

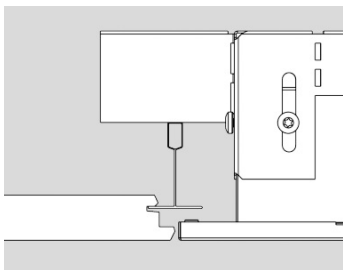

C91-R/C63-R

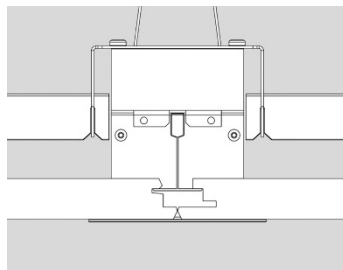

C80-R G2
(+MNT DS/T24X)

Epäsymmetrinen avattava 24mm piilolistajärjestelmä

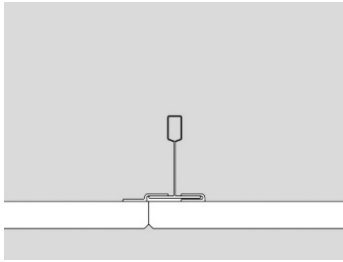

Gyproc Gyptone D1

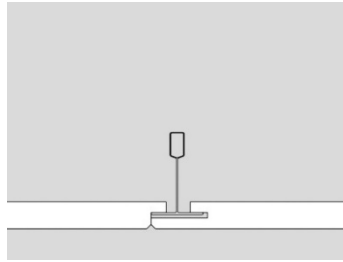

Gyproc Gyptone D2

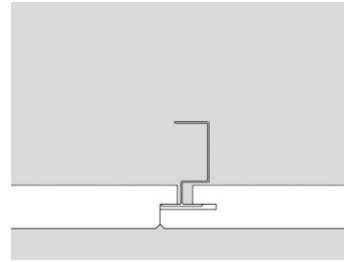

Rockfon D-XL

Esimerkkejä

AMF AW, Gyproc Gyptone D1/D2, Knauf Danoline D/D+, OWA S 9b, Paroc D, Rockfon D-XL/H

Ratkaisumme

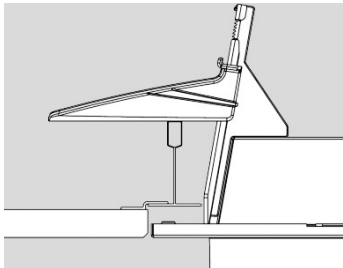

A51-R G2
(+ MNT C20-R G2)

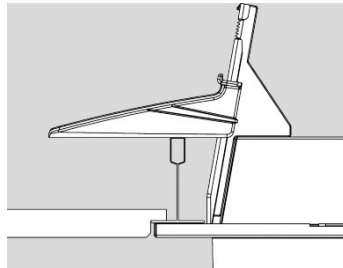

A51-R G2
(+ MNT C20-R G2)

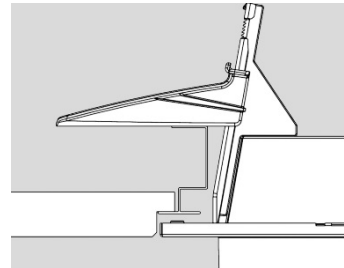

A51-R G2
(+ MNT C20-R G2)

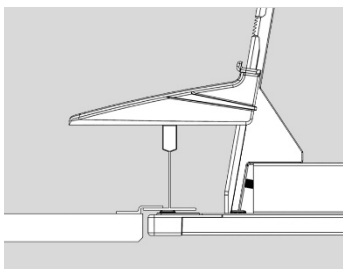

C77-R
(+ MNT C77-R)

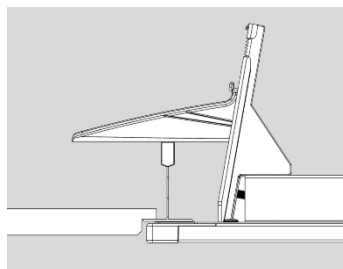

C77-R
(+ MNT C77-R)

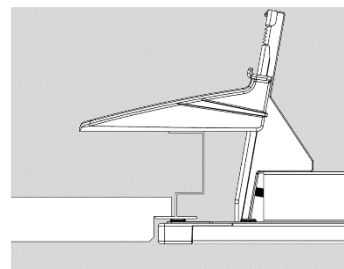

C77-R
(+ MNT C77-R)

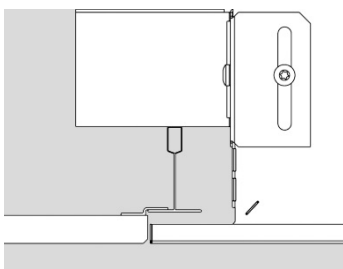

C30-RIC G2

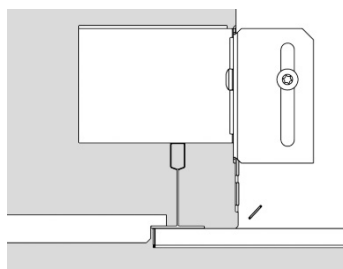

C30-RIC G2

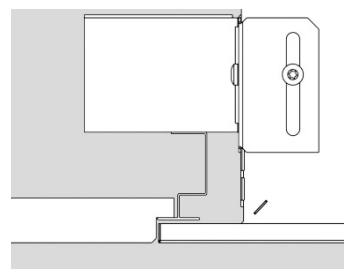

C30-RIC G2

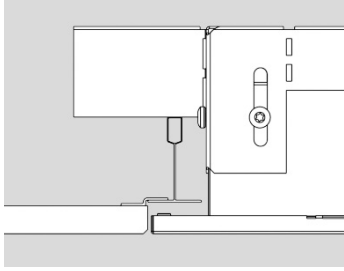

C91-R/C63-R

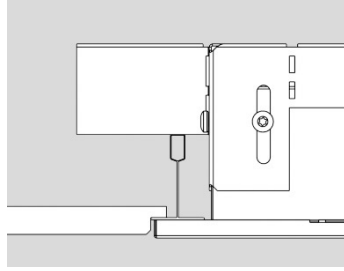

C91-R/C63-R

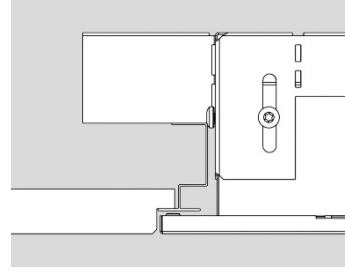

C91-R/C63-R

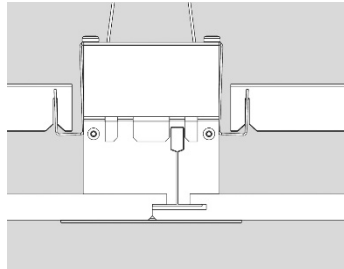

C80-R G2
(+MNT GYPTONE D2)

Epäsymmetrinen avettava 35mm piilolistajärjestelmä

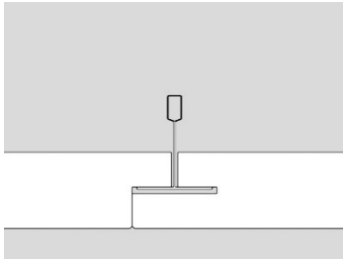

Troldekt T35

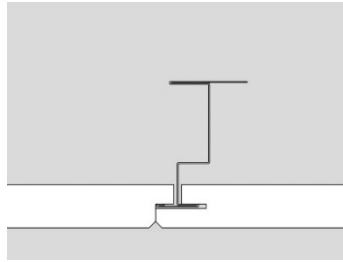

OWA S 9a

Esimerkkejä

INLOOK VK-10, Troldekt K5-FN 35, OWA S 9a

Ratkaisumme

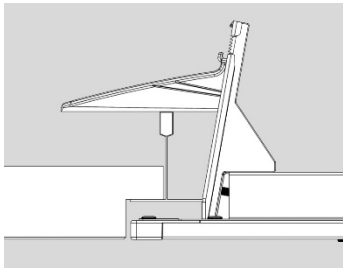

C77-R
(+ MNT C77-R)

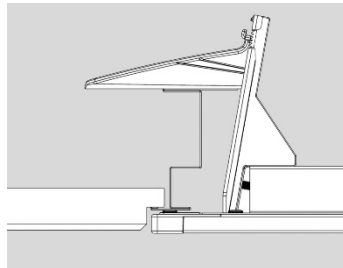

C77-R
(+ MNT C77-R)

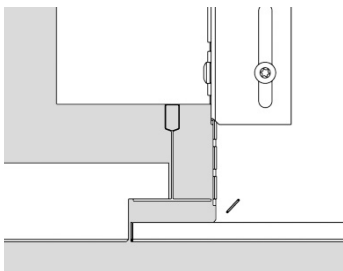

C30-RIC G2

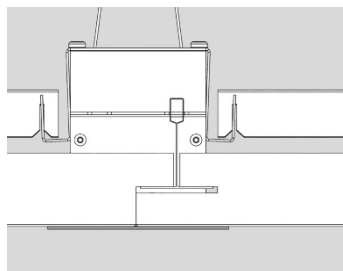

C80-R G2
(+MNT TROLDTEKT T35)

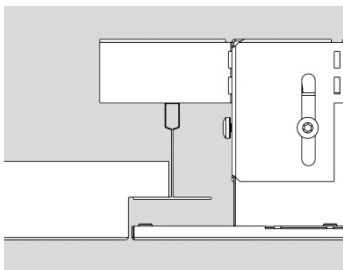

C92-R

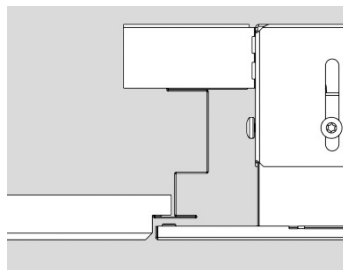

C92-R

Metallikasettikatto 16mm piilotetulla A-listajärjestelmällä

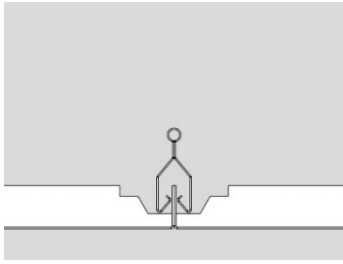

OWA S 22

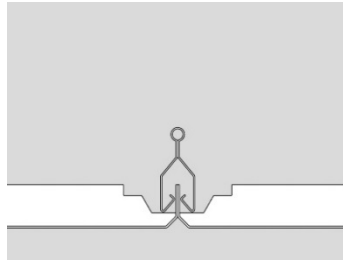

Listajärjestelmä voi olla 47, 59 tai 67 mm korkea. Kattolevyt voivat olla suoralla tai viistotetulla reunalla.

Esimerkkejä

Armstrong Q-Clip/R-Clip/S-Clip F, Burgess Clip In A-Bar, Fural K, Lindner LMD-K 420, OWA S 22/31/32, SAS 150

Ratkaisumme

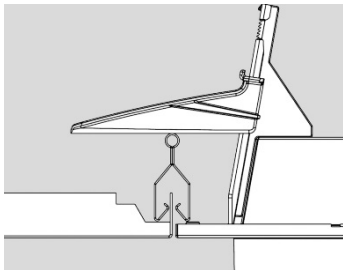

A51-R G2
(+ MNT C20-R G2)

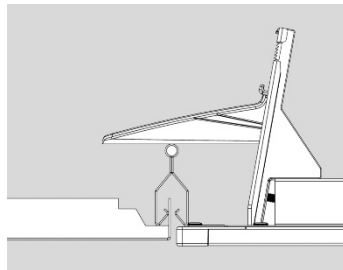

C77-R
(+ MNT C77-R)

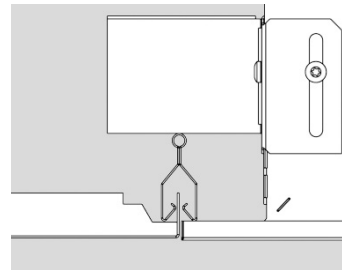

C30-RIC G2

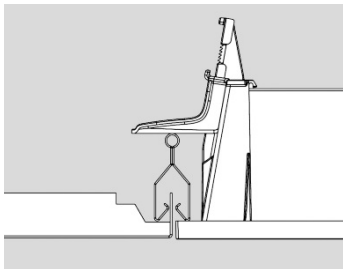

C90-R
(+ MNT C90)

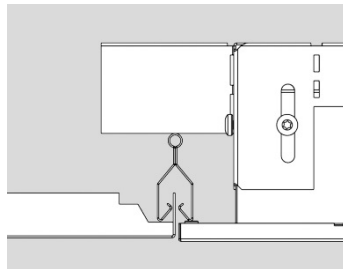

C91-R/C63-R

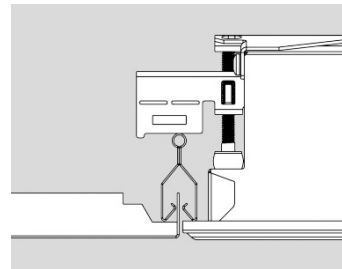

C64-R

Metallikasettikatto 36mm piilotetulla A-listajärjestelmällä

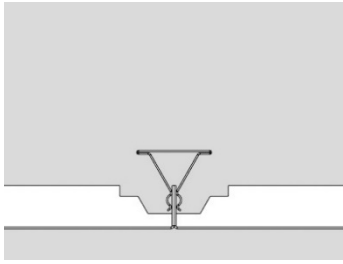

Dampa Clip-In

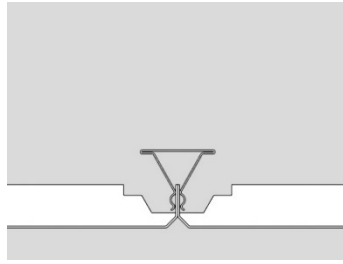

Listajärjestelmä voi olla 36 mm (Dampa Clip-In) tai 45 mm (Armstrong T-Clip F / SAS 120) korkea. Kattolevyt voivat olla suoralla tai viistotetulla reunalla.

Esimerkkejä

Armstrong T-Clip F, Dampa Clip-In, Meta Klemkassett, SAS 120

Ratkaisumme

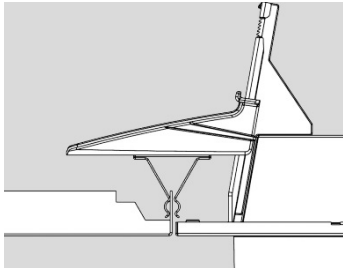

A51-R G2
(+ MNT C20-R G2)

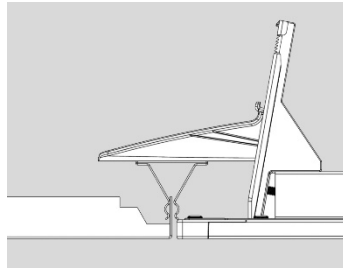

C77-R
(+ MNT C77-R)

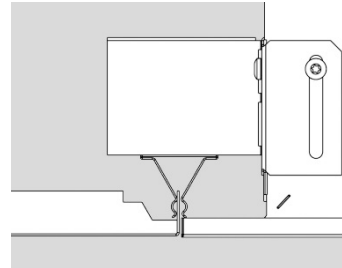

C30-RIC G2

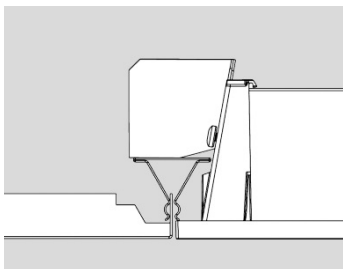

C90-R
(+ MNT SPRING-T36 C90-R)

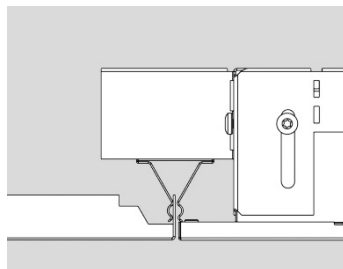

C91-R/C63-R

Metallikasettikatto 45mm piilotetulla T-listajärjestelmällä

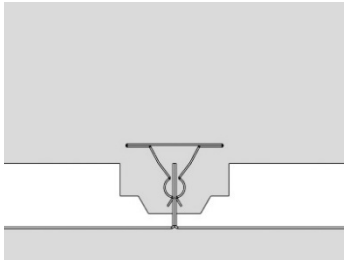

Burgess Clip-In

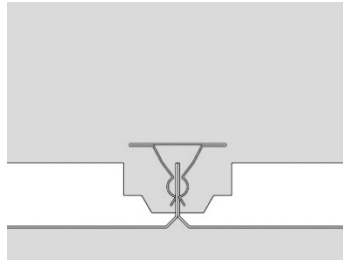

Listajärjestelmä voi olla 39 mm (Burgess Clip-In) tai 45 mm (Armstrong Orcal 1800/Burgess Clip-In) korkea. Kattolevyt voivat olla suoralla tai viistotetulla reunalla.

Esimerkkejä

Armstrong Orcal 1800, Burgess Clip-In

Ratkaisumme

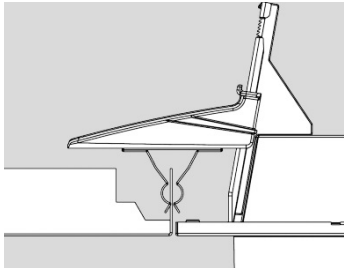

A51-R G2
(+ MNT C20-R G2)

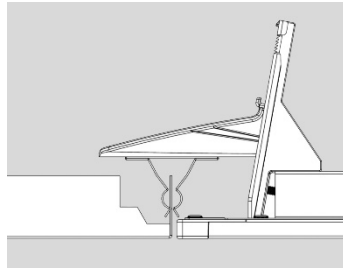

C77-R
(+ MNT C77-R)

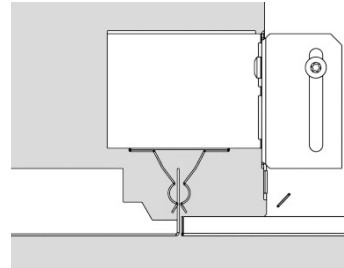

C30-RIC G2

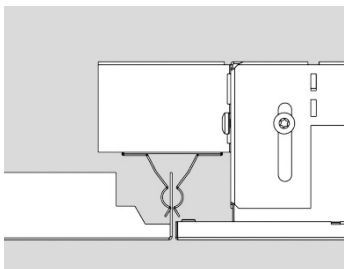

C91-R/C63-R

Suljettu modulikatto

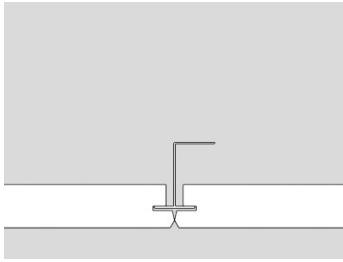

Rockfon C

Esimerkkejä

AMF GN, Rockfon C

Ratkaisumme

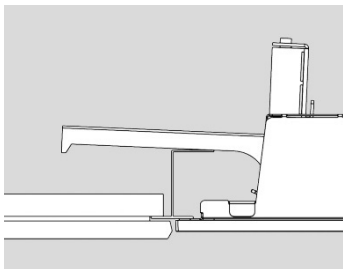

C70-R G2/C85-R
(+ MNT C70-R G2)

Kipsilevykatot

Valaisimen asennusaukko on mitoitettava valaisimen mukaan (ei standardi-mitoitusta).

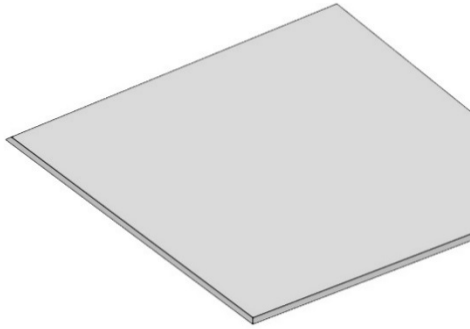

Valaisinkohtainen asennusaukon mitoitus

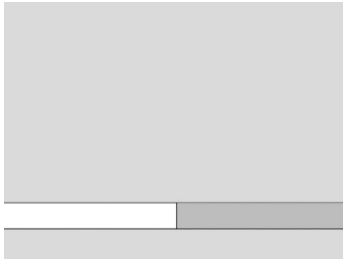

Kipsilevykatto

Ratkaisumme

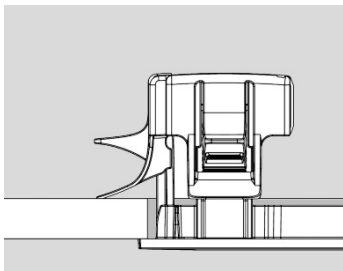

MNT FRAME PLASTERBOARD

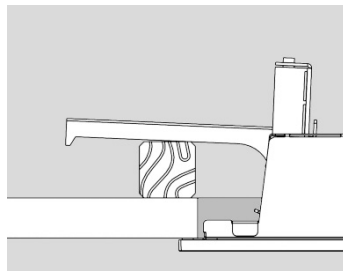

C70-R G2/C85-R
(+ MNT C70-R G2)

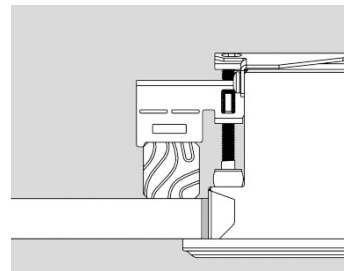

C64-R

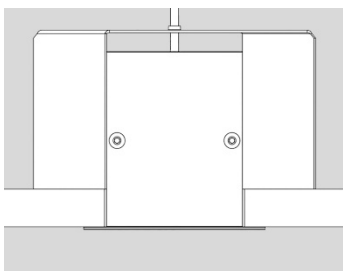

C80-R G2

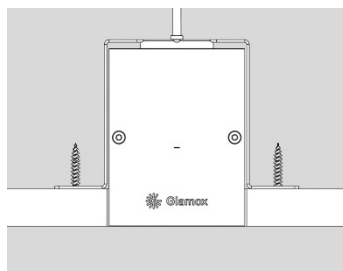

C80-S G2
(+MNT TRIMLESS)

Paneelikatot

Katto jossa kattolevyt/paneelit lepäävät lyhyeltä sivultaan kookkaiden kannatinkiskojen päällä. Paneelien leveys, muotoilu ja pituus vaihtelevat.

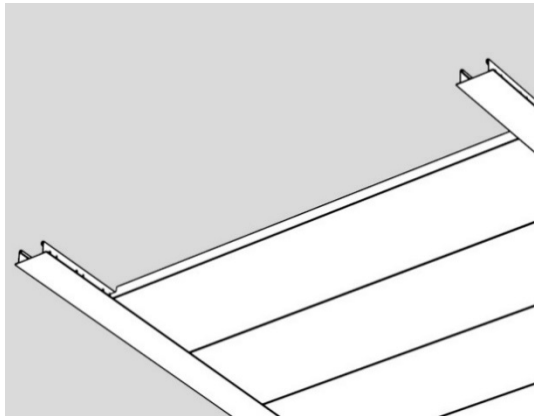

Lay-In

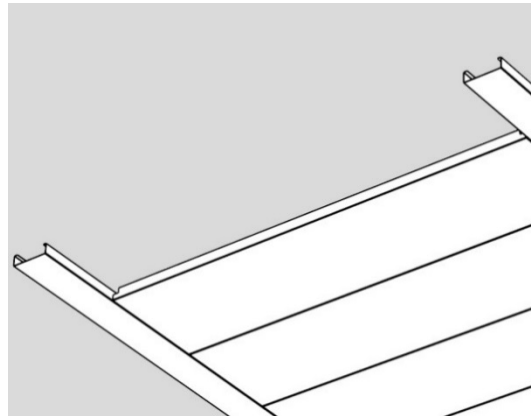

Hook-On

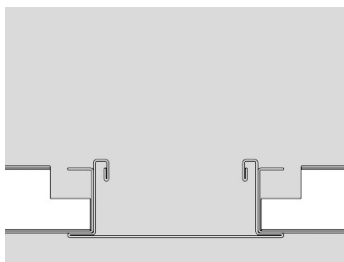

Armstrong Lay-In

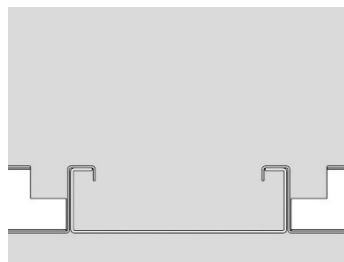

Armstrong Hook-On

Esimerkkejä

Armstrong linear grid, SAS 330

Ratkaisumme

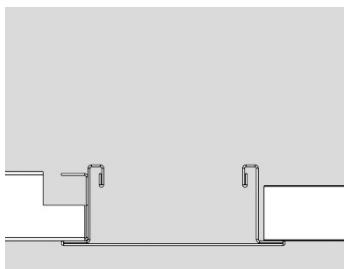

C95-R

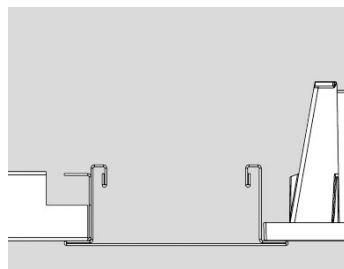

C90-R

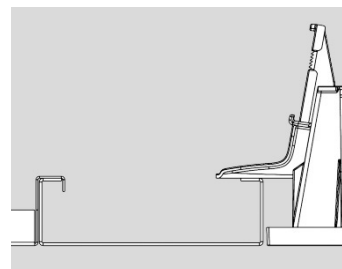

C90-R
(+ MNT C90-R)

Lay-In-kattoihin, joissa paneelin koko on 300 x 1200 tai 312 x 1250 mm, soveltuvat valaisimet C20-R G2, C63-R, C90-R ja C95-R. Hook-On -kattoihin soveltuvat parhaiten C63-R ja C90-R.

Sälekatot

Sälekattoja on useissa moduli-leveyksissä (yleensä 100, 150, 200 tai 300 mm). Kattolevyissä/säleissä on sama reunamuoto molemmilla sivuilla, joko avoin tai suljettu reuna. Säleiden korkeus ja muotoilu vaihtelee.

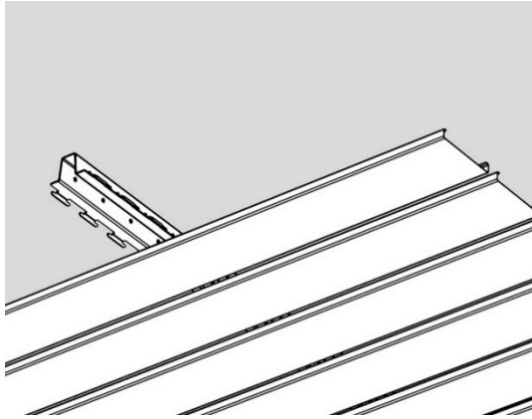

Avoin reuna

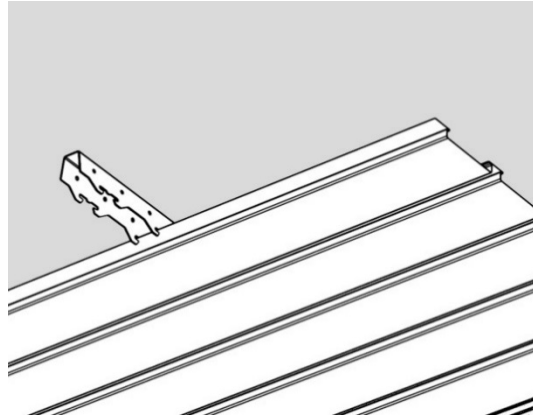

Suljettu reuna

Esimerkkejä

Dampa, Hunter Douglas

Ratkaisumme

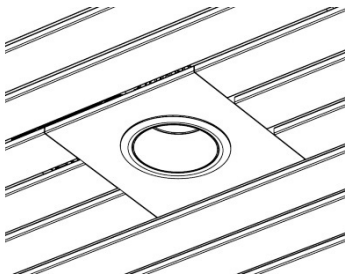

D70-R

Koska sälekattoja on lukemattomia erilaisia, on mahdoton antaa yleispätevää ohjetta mikä valaisin kattoon soveltuu. Downlight-valaisimiin on saatavana sälekattokasetteja asennusta helpottamaan. Tapauskohtaisesti myös muut upotettavat valaisimet voivat soveltua kyseiseen kattoon. Myös ripustettavat valaisimet ovat todennäköisesti toimiva ratkaisu sälekattojen kanssa.



Glamox-konserni

Glamox on norjalainen teollisuusyritys, joka kehittää, valmistaa ja toimittaa ammattivalaistuksen ratkaisuja maailmanlaajuisesti. Missiomme on tarjota kestäviä valaistusratkaisuja, jotka parantavat ihmisten hyvinvointia ja suorituskykyä.

Korkea suorituskyky ja helppokäyttöisyys

Ratkaisuissamme korkea suorituskyky ja kestävyys yhdistyvät helppokäyttöisyyteen ja yksinkertaisuuteen tarjoten ylivertaisen asiakaskokemuksen. Hyödynnämme ratkaisuissamme viimeisintä tekniikkaa ja toimitamme sitä sukupolvien kokemuksella aidosti asiakkaitamme kuunnellen.

Laatumerkit ja omistautunut tuotetuki

Tarjoamme ratkaisumme laajan valaisinvalikoimamme avulla. Merkistä riippumatta jokaisen asiakkaamme tarpeet ovat palvelumme ytimessä. Olipa kyseessä esimerkiksi tuotantolaitos, sairaala tai toimistorakennus tavoitteemme on tarjota valaistusratkaisu, joka edistää parempaa elämää asiakasyrityksillemme ja kaikille niissä työskenteleville.

Lisätietoja osoitteessa: www.glamox.fi

